



Shenzhen Waytronic Electronics Co.,Ltd. 

QUICK START GUIDE

WT2000 B04 V1.02

V1.02

2017-9-11

Note:

WAYTRONIC ELECTRONIC CO.,LTD. reserves the right to change this document without prior notice. Information provided by WAYTRONIC is believed to be accurate and reliable. However, WAYTRONIC makes no warranty for any errors which may appear in this document. Contact WAYTRONIC to obtain the latest version of device specifications before placing your orders. No responsibility is assumed by WAYTRONIC for any infringement of patent or other rights of third parties which may result from its use. In addition,WAYTRONIC products are not authorized for use as critical components in life support devices/systems or aviation devices/systems, where a malfunction or failure of the product may reasonably be expected to result in significant injury to the user, without the express written approval of WAYTRONIC.



CATALOGUE

- 1. Product overview..... - 3 -
- 2. Features..... - 3 -
- 3. Technical specification..... - 4 -
- 4. Electrical characteristics..... - 4 -
- 5. Module pin introduce..... - 5 -
- 6. Function introduction..... - 6 -
 - 6.1. ADC key function..... - 6 -
 - 6.2. Serial port communication control command..... - 6 -
 - 6.3. Control protocol..... - 7 -
 - 6.4. Write operation command about playing..... - 8 -
 - 6.4.1. Return code format..... - 8 -
 - 6.4.2. Specified file index play..... - 8 -
 - 6.4.3. File index play of specified folder(folder name 6 characters fixedly)..... - 8 -
 - 6.4.4. Pause/play command..... - 8 -
 - 6.4.5. Stop playing command..... - 9 -
 - 6.4.6. Next music command..... - 9 -
 - 6.4.7. Previous command..... - 9 -
 - 6.4.8. Volume control command..... - 9 -
 - 6.4.9. Adjust clock command..... - 10 -
 - 6.5. Operation command about recording..... - 10 -
 - 6.5.1. Specified audio input channel and gain, suitable for external signals..... - 10 -
 - 6.5.2. Set sound quality command..... - 10 -
 - 6.5.3. Specified MiC recording command..... - 11 -
 - 6.5.4. Specified file name recording command..... - 11 -
 - 6.5.5. Specified LINE-IN recording command..... - 11 -
 - 6.5.6. File name recording in specified folder..... - 11 -
 - 6.5.7. Stop recording command..... - 12 -
 - 6.5.8. Delete specified index command..... - 12 -
 - 6.5.9. Delete index file in specified folder..... - 12 -
 - 6.5.10. All delete command..... - 13 -
 - 6.5.11. Set if need to automatic delete previous recording file when recording memory is used up..... - 13 -
 - 6.6. Reading operation command..... - 13 -
 - 6.6.1. Read current volume setting..... - 13 -
 - 6.6.2. Read current working state..... - 14 -
 - 6.6.3. Read the total music files..... - 14 -
 - 6.6.4. Read the total music files of specified folder..... - 14 -
 - 6.6.5. Read current connection status of SD card and U disk(CA)..... - 14 -



6.6.6. Read storage free space.....	- 15 -
6.6.7. Read time information.....	- 15 -
7. Time seting way.....	- 16 -
8. Attention.....	- 16 -
9. The way of read file in the module.....	- 16 -
9.1. Copy the audio file.....	- 16 -
9.2. Finish copying.....	- 17 -
10. Application circuit.....	- 18 -
10.1. MIC recording application circuit.....	- 18 -
10.2. LINE-IN recording application circuit.....	- 18 -
10.3. Aux recording application circuit.....	- 19 -
10.4. key application circuit.....	- 19 -
11. Histoty version.....	- 20 -



1. Product overview

With the development of society and the improvement of human rights consciousness, enterprises and service units need to improve their own sense of service, how to manage and supervise the following performers. It is always used to monitor records, so long recordings and video records go into the life. So on-board recorder, taxi recording black boxes, intercom recording, security monitoring and railway communication recording and a series of products need long time recording, and can be repeated recording, you can copy or upload, according to the law of the classified storage, with features such as time logo. Other functional applications of these products have been relatively mature, so it is generally not possible to design the original product.

2. Features

- Support 8k-44.1k sample rate, 8-320kbps bit rate MP3 audio file.
- Support WAV, WMA, MP3 audio format, high quality sound.
- Support 8k-44.1k sample rate WAV audio file.
- Support 8k-44.1k sample rate WMA audio file.
- Support MIC recording, LINE-IN recording, AUX recording.
- Use TF card and U disk as memory, max 32G.
- Adopt FAT and FAT32 file system.
- Freely change audio contents of TF card through USB interface on PC computer.
- Support USB sound card function.
- Universal asynchronous serial UART communication, universal standard interface protocol, easy and flexible to control.
- DACL and DACR output, 32-level volume for adjustment.
- Built in clock module and battery.
- DC 5V supply power, can charge for the battery when supply power.
- Can set the time via send the serial port command.
- Can set automatic delete function, to ensure delete earliest recording file when the capacity is used up. (module return FULL: 0x46 0x55 0x4C 0x4C)
- The initialize time is 3S when power on.

3. Technical specification

Name	Function
Support audio format	Sample rate 8K~44.1K, bit rate 8~320Kbps MP3 audio file Sample rate 8K~44.1K WAV audio file Sample rate 8K~44.1K WMA audio file
Support storage	Maximum 32GB TF card Maximum 32GB U disk
USB interface	Full speed 2.0
Supply voltage	DC3.3~5V
Rated current	20~250mA(related with load)
IO port level	3.3V TTL level
Dimension	21.3mm*37.2mm
Working temperature	-40~85°C
Humidity	5%~95%

4. Electrical characteristics

Name	Function	Minimum	Typical value	Maximum	Unit	condition
VDD50	LDO input voltage	3.0	5.0	5.5	V	-
SNR	Signal noise ratio	-	92	-	dB	-
THD+N	Total Harmonic Distortion	-	-70	-	dB	No-load
Ps1	Standby power consumption (withTFcard)	-	27.6	-	mA	Relate to the TF power consumption
Prec	Recording power consumption (with TFcard)	-	28.1	-	mA	Relate to the TF power consumption
VPPLINE	External audio input amplitude	-	-	2.8	V	

5. Module pin introduce

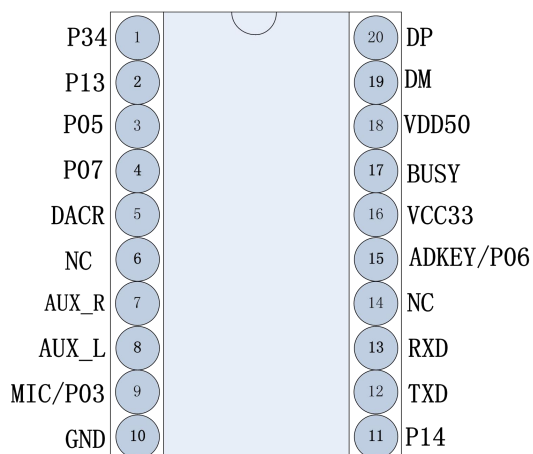

WT2000B04

Pin NO	Pin name	Type	Function description
	P34	I	Detect level change, usually high level, 100 ms low level trigger MIC recording/stop recording
	P13	I	Detect level change, usually high level, 100 ms low level trigger MIC recording/stop recording
	P05	I	NC(undifined)
	P07	I	NC(undifined)
	DACR	O	DAC audio output of module
	NC	O	NC(undifined)
	AUX_L	IO	AUX record audio signal left channel input port
	AUX_R	IO	AUX record audio signal right channel input port
	MIC	AI	Microphone Termina
	GND	PWP	Power Ground
	P14	I	NC(undifined)
	TXD	O	UART asynchronous serial data output port
	RXD	I	UART asynchronous serial data input port
	NC	I	NC(undifined)
	ADKEY	I	ADC key connect port (can extend differnt key function)
	VCC33	O	3.3V steady voltage output
	BUSY	I	Playing andRecording state indicate(usually as the low level, as high when playing and recording)
	VDD50	PWP	Power input port (3.0V~5.5V)
	DM	IO	USB data port DM
	DP	IO	USB dasta port DP

6. Function introduction

6.1. ADC key function

ADC key resistance corresponding function:

Resistance	Function
0R	Play/pause
1K	next
2K	previous
10K	stop

6.2. Serial port communication control command

Support UART communication, baud rate: 9600bps; start:bit: 0, stop bit: 1; format: start bit (1bit) + data bit(8bit) + stop bit(1bit). Data is transferred at the byte of 8bits, low bit first.

CMD	Function	Input parameter
A2	Specified file index play	File index
A4	File index play of specified folder	Folder name, file index
AA	Play/pause command	No
AB	Stop playing command	No
AC	Next	No
AD	Previous	No
AE	Volume control command	Volume level
BC	Send corresponding time information, write into clock chip	Adjust time
D3	Specified audio input channel and gain	Channel mode
D4	Set sound quality	Bit rate selection
D5	MIC time recording	
D6	Specified file name recording command	File name
D7	LINE-IN time recording	
D8	File name of specified folder recording command	File name, folder
D9	Stop recording	No
DA	Delete specified index command	Index
DC	Delete the index of specified folder	Folder, index
DE	All delete	No
E0	Set if need to automatic delete when recording memory is used up	automatic delete sign

Communication query command

CMD	Function	Return parameters
C1	Query current volume setting	0XC1, volume value
C2	Query current working state	0XC2, working mode
C5	Read the total music files of root directory in storage	0XC5, hexadecimal
C6	Read the total music files of specified folder in storage	0XC6, hexadecimal
CA	Read current connection status of SD card and U disk	0XCA connection status
CE	Read storage free space	0XCE capacity
F0	Read time information	Return:F0 XXXXXXXX current time

6.3. Control protocol

WT2000 is built in standard UART serial port interface, belonging to 3.3V TTL level interface. Can convert to RS232 level through MAX3232 chip. Communication data format: start bit: 1bit; data bit: 8 bits; parity bit: none; stop bit: 1 bit. Use computer serial debugging assistant, need to set parameters of serial port correctly, as shown below.



Protocol command format:

Start code	Length	Operation code	Parameters	Check code	End code
0X7E	See below	See below	See below	See below	0XEF

Note: All data are hexadecimal. "Length" means length + operation code + parameter length + check sum(check code uses one byte, only low 8 bits reserved, over 8bits, discard). See as follows specified file index play command; length is 5 bytes.

6.4. Write operation command about playing

6.4.1. Return code format

Operation code
XX

Note: After executing each write command, return the corresponding one-byte operation code.

6.4.2. Specified file index play

This command can specify index audio play of storage, influenced by the order of file stored. Files sorting is according to the index order.

Start code	Length	Command	High order of track	Low order of track	Check code	End code
7E	05	A2	00	01	A8	EF

Note: when specify to play, if specified audio does not exist, stop playing.

Return code: →00 means OK, start to play.

→ 01 means EMP, no such file.

6.4.3. File index play of specified folder(folder name 6 characters fixedly)

Search the audio of folder from root directory first.

Start code	Length	Command	Folder name(high-low)				File index(high-low)		Check code	End code	
7E	0A	A4	'M' (4D)	'U' (55)	'S' (53)	'I'(49)	'C' (43)	00	01	30	EF

Only folder name exists in the form of ASCLL code; above commands mean playing the first audio file (index number is 0001) of "MUSIC" folder in the specified root directory.

Return code: →00 means OK, start to play.

→ 01 means EMP, no such file.

6.4.4. Pause/play command

Start code	Length	Command	Check code	End code
7E	03	AA	AD	EF

Send this command in the first time, the music will pause; send this command again, music will continue to play from which it pauses.

Response →00 means OK, command execution succeeds;

→01 means FAIL, command error.

6.4.5. Stop playing command

Start code	Length	Command	Check code	End code
7E	03	AB	AE	EF

Send this command, current playing music will be stopped

Response →00 means OK, command execution succeeds;

→01 means FAIL, command error.

6.4.6. Next music command

Start code	Length	Command	Check code	End code
7E	03	AC	AF	EF

This command can trigger to play the next music. When playing the last music, sending this command will trigger to play the first music.

Response →00 means OK, command execution succeeds;

→01 means FAIL, command error.

6.4.7. Previous command

Start code	Length	Command	Check code	End code
7E	03	AD	B0	EF

This command can trigger to play the previous music. When playing the first music, sending this command will trigger to play the last music.

Response →00 means OK, command execution succeeds;

→01 means FAIL, command error.

6.4.8. Volume control command

Volume has 32 levels, 00~31, 00 is mute; 31 is the max volume(default volume level is 16)

Start code	Length	Command	Volume level	Check code	End code
7E	04	AE	1F	D1	EF

Example shows that sending maximum volume 31 level. This command is available to adjust volume in real time, power-off memory(when EEPROM exists).

Response →00 means OK, command execution succeeds; the playing volume is a specified value.

→01 means FAIL, command error.

6.4.9. Adjust clock command

Volume has 32 levels, 00~31, 00 is mute, 31 is the max volume(default volume level is 16)

Start code	Length	Command	Year(4BYTE)				Month		Day		Hour		Minute		Second		Check code	End code
7E	11	BC	32	30	31	34	30	31	30	32	31	32	35	33	35	31	XX	EF

This example shows 12 o'clock 53 minutes 51 seconds, Jan. 2, 2014. This command can modify real-time clock time of clock chip.

For the compatibility with USB reading TXT, so adopt the way of reading ASIIX code.

Response →00 means OK, command execution succeeds; time modification is finished.

→01 means FAIL, command error.

6.5. Operation command about recording

6.5.1. Specified audio input channel and gain, suitable for external signals

WT2000 can choose audio input channel MIC and AUX, at the same time, can set internal gain amplitude.

Start code	Length	Command	Parameter	Check code	End code
7E	04	D3	00: MIC signal gain 10DB(default)	D7	EF
			01: external LINE-IN signal gain 3DB	D8	
			02: external double-channel AUX(AUX_L and AUX_R) signal gain 3DB	D9	

Note: 1. Signal input and gain. Please refer to the following application circuit diagram when using.

2. Double-channel AUX recording, stereo effect.

Return code: → 00 means OK, command execution;

→ 01 means command not executed.

6.5.2. Set sound quality command

choose the bit rate of mp3 recording.

Start code	Length	Command	Parameter	Check code	End code
7E	04	D4	00: 128kbps	D8	EF
			01: 96kbps	D9	
			02: 64kbps(default)	DA	
			03: 32kbps	DB	

Return code: → 00 means OK, command execution;

→ 02 means command not executed.

6.5.3. Specified MiC recording command

This function is equivalent to trigger the first pin to start recording.

Start code	Length	command	Check code	End code
7E	03	D5	D8	EF

6.5.4. Specified file name recording command

This command can specify file name recording generated in root directory (file name 8 characters at most, not support long file name)

Start code	Length	Command	File name (form high to low)				Check code	End code
7E	07	D6	54('T')	30('0')	30('0')	32('2')	C3	EF

“54, 30, 30, 32” are ASCLL codes of T002. Only folder name exists in the form of ASCLL code; above commands mean that “T002.MP3” file generated in the specified root directory starts to record.

Return code: →00 means OK, start to record.

→ 46 55 4C 4C means memory full.

→ 02 means error, unsuccessful.

6.5.5. Specified LINE-IN recording command

This function is equivalent to trigger the second pin to start recording.

Start code	Length	command	Check code	End code
7E	03	D7	DA	EF

Return code: →00 means OK, start to record.

→ 46 55 4C 4C means memory full.

→ 02 means error, unsuccessful.

6.5.6. File name recording in specified folder

This command can specify file name recording in specified folder of root directory (folder 6 characters, file name



8 characters at most, not support long file name)

Start code	Length	Command	Folder name(high-low)					File index(high-low)				Check code	End code
			'M' (4D)	'U' (55)	'S' (53)	'T'(49)	'C' (43)	54 'T'	30 '0'	30 '0'	32 '2'		
7E	0C	D8										4B	EF

“54, 30, 30, 32” are ASCLL codes of T002. Only folder name exists in the form of ASCLL code; above commands mean that “T002.MP3” recording file generated in “MUSIC” folder in the specified root directory starts to record.

Return code: →00 means OK, start to record.

→ 46 55 4C 4C means memory full.

→ 02 means error, unsuccessful.

6.5.7. Stop recording command

Start code	Length	Command	Check code	End code
7E	03	D9	DC	EF

After receiving this command, stop recording, and generate audio file that finished recording.

Response →00 means OK, stop recording and generate audio file(file name is specified by record command).

→02 means FAIL, command error, or audio file generation is unsuccessful.

6.5.8. Delete specified index command

This command can specify to delete the corresponding index audio file of root directory.

Start code	Length	Command	File index (form high to low)		Check code	End code
7E	05	DA	00	02	E1	EF

“00,02” means the second file of index corresponding, above command means delete the second file in root directory.

Return code: → 00 means OK, delete successfully.

→ 02means no such file.

6.5.9. Delete index file in specified folder

This command can specify to delete the corresponding index audio file of root directory.(file name is 5 characters fixedly)

Start code	Length	Command	Folder name(high-low)	File index(high-low)	Check code	End code



7E	0A	DC	'M' (4D)	'U'(55)	'S'(53)	'I' (49)	'C' (43)	00	02	69	EF
----	----	----	-------------	---------	---------	-------------	-------------	----	----	----	----

Only folder name exists in the form of ASCLL code; above commands mean specify to delete the MP3 file with index number 0002 (the second) in "MUSIC" folder of root directory.

Return code: → 00 means OK, delete successfully.

→ 01 means no such file.

6.5.10. All delete command

Start code	Length	Command	Check code	End code
7E	03	DE	E1	EF

After receiving this command, all audio files will be deleted.

Response: → 00 means OK, delete successfully.

→ 02 means delete error, not executed.

6.5.11. Set if need to automatic delete previous recording file when recording memory is used

up

Start code	Length	Command	Parameter	Check code	End code
7E	03	E0	00	XX	EF

Parameter description: 00-> means the default mode, that is, will automatic delete previous recording file when the memory is full.

01-- -> indicates that the device will reminder wrong when memory is full and does not delete the earliest recording files and stop recording.

The remaining parameters return 02 error codes.

The default is 00, which is automatic delete previous recording file when the memory is full.

6.6. Reading operation command

6.6.1. Read current volume setting

Start code	Length	Command	Check code	End code
7E	03	C1	C4	EF

Return format:

Operation code	Return value
----------------	--------------

0XC1	Volume value (00-1F)
------	----------------------

6.6.2. Read current working state

Start code	Length	Command	Check code	End code
7E	03	C2	C5	EF

Return format:

Operation code	Return value
0XC2	01: play; 02: stop; 03: pause; 04: record;

6.6.3. Read the total music files

Start code	Length	Command	Check code	End code
7E	03	C5	C8	EF

Return format:

Operation code	Return value
0XC5	Total Files(sixteen-bit value)

6.6.4. Read the total music files of specified folder

Start code	Length	Command	Folder name(high-low)					Check code	End code
7E	08	C6	'M' (4D)	'U' (55)	'S' (53)	'I' (49)	'C' (43)	4F	EF

Return format:

Operation code	Return value
0XC6	Total files(sixteen-bit value)

Note: it's recommended to use A0 play command to update total files in cache and then read, otherwise, what you read is the total saving cache files in the last update.

6.6.5. Read current connection status of SD card and U disk(CA)

Start code	Length	Command	Check code	End code
7E	03	CA	CD	EF

Return format

Operation code	Return value
0XCA	XX

When SD card or U disk is inserted or removed, WT2000 will return data by itself for prompt.

Return value: 00 means SD card and U disk exist; 01 means SD card exists while U disk not; 02 means no SD card while U disk exists; 03 means neither SD card nor U disk exist.

The state is represented by a byte of data

SD card -- -- -- -- > BIT1

U disk -- -- -- -- -- > BIT2

PC -- -- -- -- -- -- -- > BIT3

Return value: if the device is online, place it, not online, then set 0

CA 00 no device, no connect to PC

CA 02 SD card is online, no usb flash drive, not connect to PC

CA 04 U disk is online, no SD card, no connect to PC

CA 08 connect to PC, U disk and SD card are not online

CA 06 U disk and SD card are online, not connect to PC

CA 0A SD card is online, no U disk, connect to PC

6.6.6. Read storage free space

Start code	Length	Command	Check code	End code
7E	03	CE	D1	EF

Return format:

Operation code	Return value
0XCE	XXXX remaining capacity(M)

Note: it's recommended to use A0 play command to update total files in cache and then read, otherwise, what you read is the total saving cache files in the last update.

6.6.7. Read time information

Start code	Length	Command	Check code	End code
7E	03	F0	F3	EF

Return format:

Operation code	Return value
0XF0	77 DD 0C 1E 0C 14 30

Note: this return time is 12 o'clock 20 minutes 48 seconds, Dec. 30, 2013.

7. Time setting way

- 1) built-in RTC clock , can control WT2000 setting and reading time information through UART, and also enable WT2000 to automatically obtain the setting information and setting, clock supply the power independently.
- 2) can set the time function, Put a TM.TXT text in the U disk directory, the text content to set the current time (such as: the current time is 2013 on December 18, 20 hour 22 minutes and 35 seconds when the input "20131218202235").After inserting the usb flash drive, the WT2000 reads the text of TM. TXT in the disk root directory and will read the content to modify the current time.After the setup is completed, the TM. TXT text will be deleted automatically.

8. Attention

During the process of recording, if fill up the storage, it will end automatically and return 01 00.

When deleting audio files, no power off or not remove storage. That will cause file corrupted even storage data destruction.

Recording data is saved every 5 seconds. If there is power off halfway, recording data within 5 seconds will be lost.

The commands of start record and end record take a bit long time to return, related with storage file also related with reading and writing speed, need to wait patiently. When receiving return code, that means execution finished. Time interval of sending each command is not less than100ms.

Automatic delete function, to ensure that the capacity is about to run out, automatically delete the earliest recorded files, reserve space to save the latest files

9. The way of read file in the module

9.1. Copy the audio file

The audio file of WT2000 order as index sort, is according to the storage first and last sort of audio file into SD card, not the sort order of file name. So WT200S play file as the index, not relate to the sort of order and file name, only relate to the order when copy file.

Because of the file order of Windows system, most cases order as file name, so we suggest, to adopt the method of serial number and the original file name, such as 0001 ode to the motherland. Mp3, 0002 story of spring. Mp3, etc.This is convenient for Windows system sorting.After you have named all the audio files on your computer, arrange them in order, and then copy them to the root of your memory.

Two common copy methods:

1. Use the shortcut key “Ctrl+C” and “Ctrl+V”,but notice that mouse can’t click any picked up file,or it will send from the file clicked by mouse.It will disorganize the order of file.

2. Arrange the order of file, choose the file need to be sent, then use the right key to click the first file(for example 001 singing motherland.mp3), in right key menu choose the root directory, send to SD card. (Note that the right key click the first file being sending,system will send from this file.)

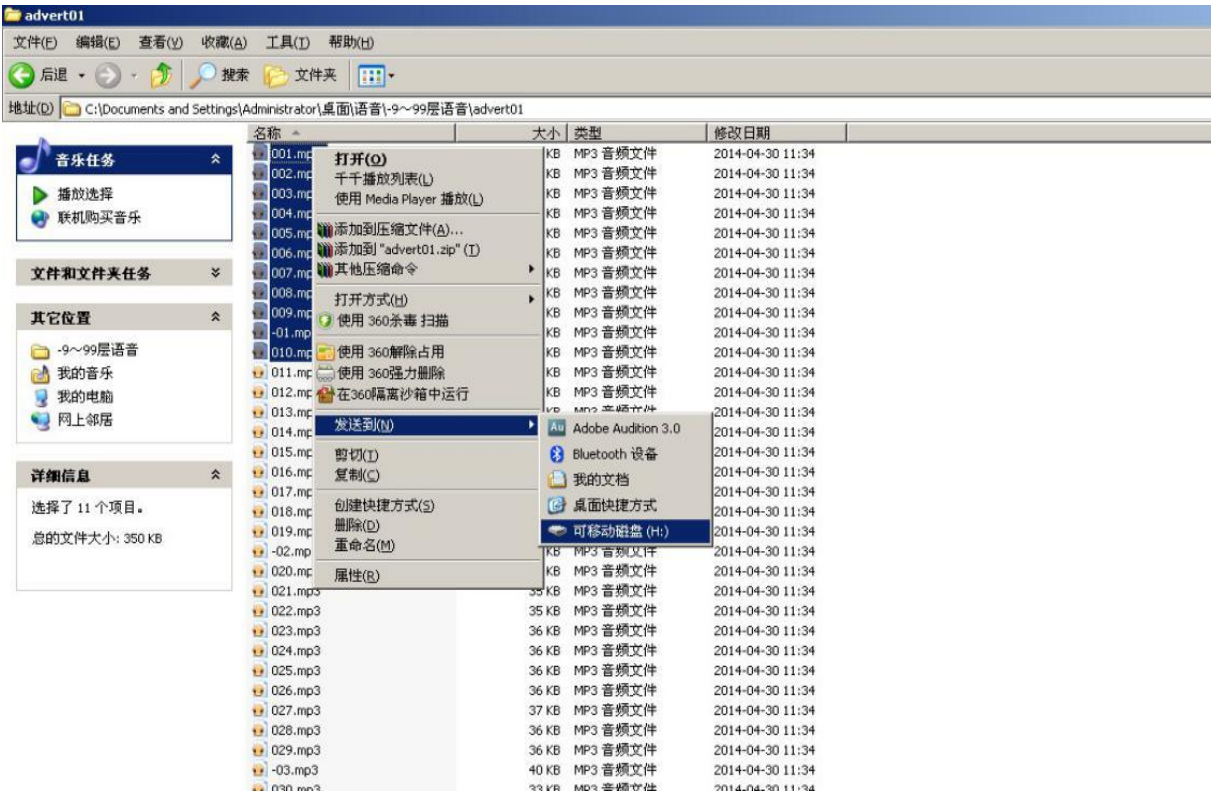

9.2. Finish copying

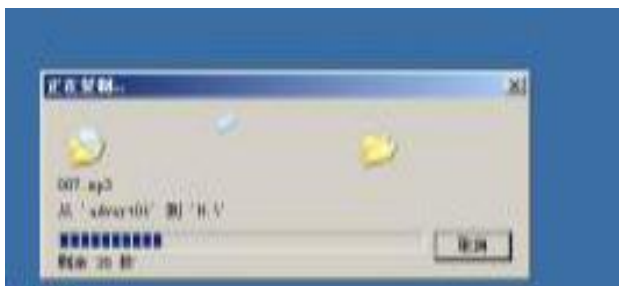

10. Application circuit

10.1. MIC recording application circuit

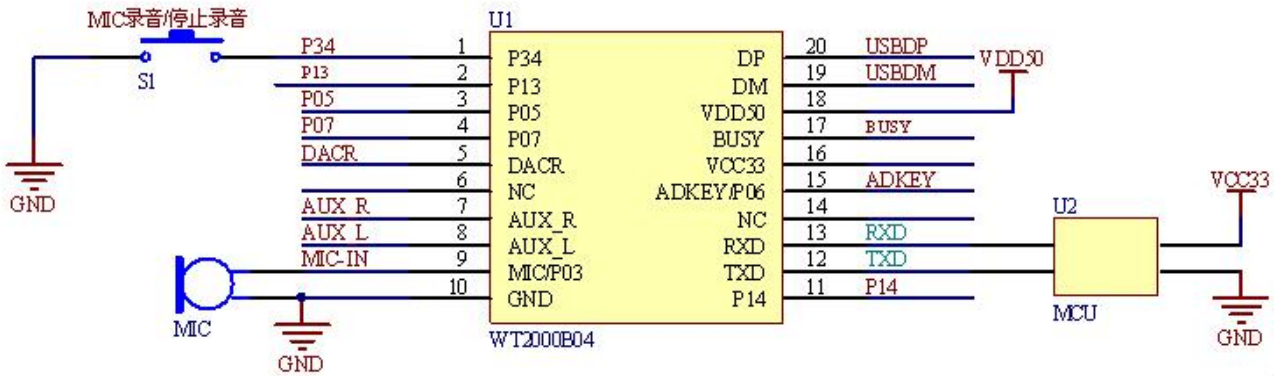

Remake:

1. If you don't want to use the key, Pin 1 can be empty.
2. The IO port voltage is 3.3V,(supply power voltage range is 3.0V-5.5V)
3. The function of key S1 is MIC recording/stop recording.

10.2. LINE-IN recording application circuit

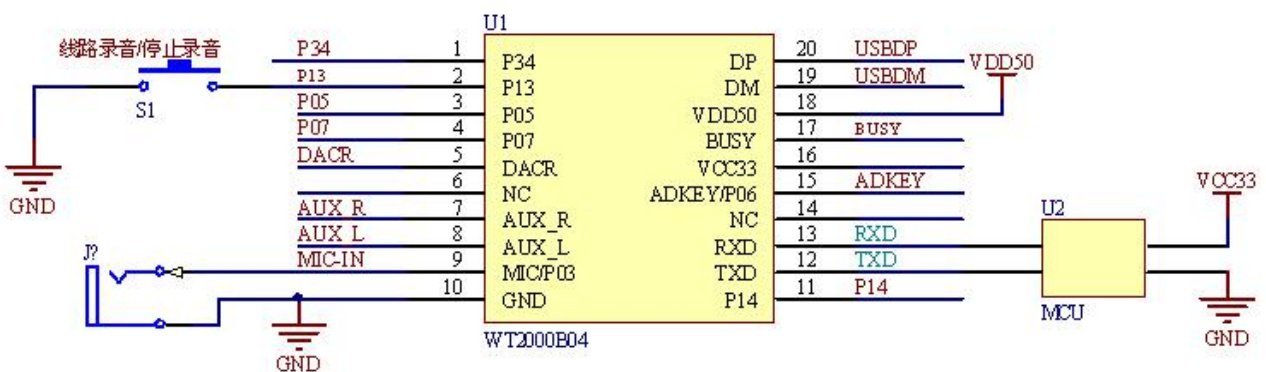

Remake:

1. If you don't want to use the key, Pin 2 (ADkey) can be empty.
2. The IO port voltage is 3.3V,(supply power voltage range is 3.0V-5.5V)
3. The function of key S1 is LINE-IN recording/stop recording.

10.3. Aux recording application circuit

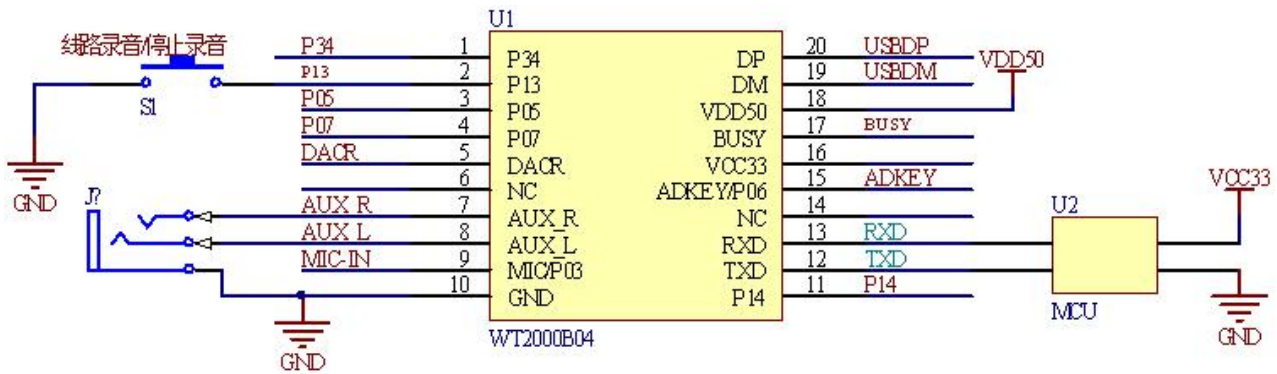

Remake:

1. If you don't want to use the key, Pin 2 (ADkey) can be empty.
2. The IO port voltage is 3.3V, (supply power voltage range is 3.0V-5.5V)
3. The function of key S1 is LINE-IN recording/stop recording.

10.4. key application circuit

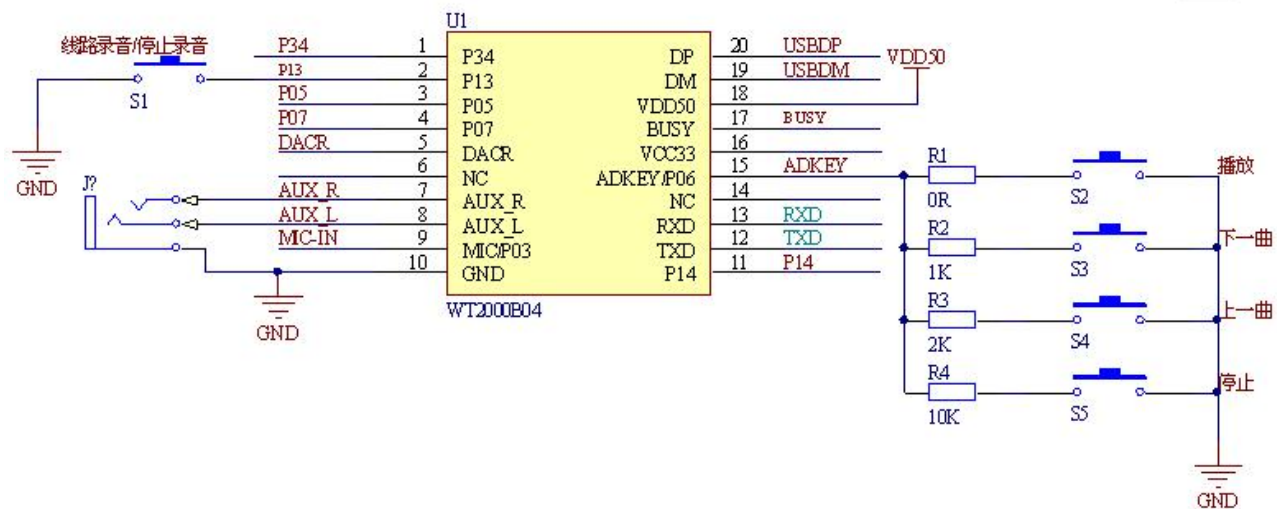

Remake:

1. The IO port voltage is 3.3V, (supply power voltage range is 3.0V-5.5V)
2. The function of key S1 is LINE-IN recording/stop recording.
3. The function of key S2 is play
4. The function of key S3 is next one.
5. The function of key S4 is previous one.
6. The function of key S5 is stop.



11. Histoty version

Version NO.	Modify Date	Description
V1.00	2016-04-01	Original Version
V1.01	2016-09-27	Modify pin function and schematic diagram
V1.02	2017-02-10	Modify company address